



TROUBLE IN TOYLAND

The 33rd Annual Survey of Toy Safety

PIRGIM
Education Fund

November 2018

PIRG **W** CONSUMER
WATCHDOG

Trouble in Toyland

The 33rd Annual Survey of Toy Safety



Written by:

Tano Toussaint and Adam Garber
U.S. PIRG Education Fund

November 2018



Acknowledgments

PIRGIM Education Fund thanks the Colston Warne program of Consumer Reports for supporting our work on consumer protection issues. Additional thanks to individual contributors for their generous support of our work on toxics, public health, and consumer issues.

The authors bear responsibility for any factual errors. Policy recommendations are those of PIRGIM Education Fund. The views expressed in this report are those of the authors and do not necessarily reflect the views of our funders or those who provided review.

© 2018 PIRGIM Education Fund. Some Rights Reserved. This work is licensed under the Creative Commons Attribution-NonCommercial-NoDerivatives 4.0 International License. To view a copy of this license, visit <http://creativecommons.org/licenses/by-ncnd/4.0/> or send a letter to Creative Commons, PO Box 1866, Mountain View, CA 94042, USA. All images of recalled toys were taken from the CPSC website. All other pictures of toys were taken by PIRGIM Education Fund staff. The CPSC did not contribute to this report nor does it endorse this report, PIRGIM Education Fund, or its affiliates.

With public debate around important issues often dominated by special interests pursuing their own narrow agendas, PIRGIM Education Fund offers an independent voice that works on behalf of the public interest. PIRGIM Education Fund works to protect consumers and promote good government. We investigate problems, craft solutions, educate the public, and offer citizens meaningful opportunities for civic participation. For more information about PIRGIM Education Fund or for additional copies of this report, please visit www.pirgimedfund.org.

Report layout and cover design: Alec Meltzer, meltzerdesign.net

Cover photo: FamVeld via Shutterstock

Table of Contents

Executive Summary	1
Introduction	4
The Road to Safer Toys	4
The Need to Improve Recall Effectiveness.....	5
Hazards in Toys	6
Toxic Hazards	6
Lead.....	6
New Toxic Threats	8
Choking Hazards	9
Small Parts	9
Small Balls.....	11
Balloons	12
Magnets	13
Smart Toys & Internet-Connected Children’s Products	14
Excessive Noise	15
Overheating of Batteries and Chargers	16
Toy Safety Victories	17
Small Parts Ban (1979).....	17
The Child Safety Protection Act of 1994.....	17
The Consumer Product Safety Improvement Act of 2008	17
Recommendations	18
Methodology	20
Appendix 1. Potentially Hazardous Toys	22
Appendix 2. Reported Toy-Related Deaths, 2001-2016	27
Appendix 3. CPSC Characteristics of Toys for Children Under Three	28
Appendix 4. CPSC-Recalled Toys from October 5, 2017 to October 26, 2018	29
Endnotes	51

Executive Summary

For over 30 years, U.S. PIRG Education Fund has conducted an annual survey of toys to look for safety problems. This research has led to more than 150 toy recalls and other regulatory actions over the years. Our work has also helped educate the public and policymakers on the need for continued action to protect the health and well-being of children. This year, we celebrate the 10th anniversary of the Consumer Product Safety Improvement Act (CPSIA) passing, which strengthened protections against dangerous consumer products.

Toys are safer than ever before, thanks to decades of work by product safety advocates, parents, the leadership of Congress, state legislatures, and the Consumer Product Safety Commission (CPSC).

Despite this progress, our survey of 40 toys this year found 15 toys with issues including toys with high concentrations of unsafe chemicals and with potential choking hazards. With hundreds of new toys hitting the market every year, our survey of only 40 toys suggests there may be other potentially dangerous toys slipping through existing protections or worthy of further investigation. This report not only lists the potentially dangerous toys that we found this year, but also describes why and how the toys could harm children.

Our independent testing covered just 40 of the thousands of toys that are on store

shelves right now. The continued presence of hazards in toys highlights the need for enhanced vigilance on the part of government agencies and the public to ensure that unsafe toys do not harm children.

Standards for toy safety are enforced by the CPSC. Safety standards include limits on toxic substances in children's products, size requirements for toys for small children, warning labels about choking hazards, measures to keep magnets and batteries inaccessible, and noise limits.

U.S. PIRG Education Fund staff examined toys to confirm that they are safe. We discovered that potentially unsafe toys remain widely available. The problems we found include:

- **Boron:** We found significant concentrations of boron, as high as 4700 parts per million (ppm) in popular slime toys. Due to significant evidence that that these levels of boron are hazardous upon ingestion, the European Union, United Arab Emirates, Canada and Jordan have all taken action to protect children's health.
- **Small parts** are pieces that might block a child's airway. Children, especially those under age three, can choke on small parts. Our researchers identified

toys that contain small parts, but do not have warning labels when sold online - including Hatchimals and L.O.L. Surprise toys.

- **Balloons** cause more children to choke to death than any other toy or children's product. We found that 87% of the latex balloons we surveyed on Amazon's website lacked the legally required warning indicating that the toy presents a choking hazard for children under 8. We also found a balloon set on store shelves that has misleading warning labels that make it appear safe for children between ages 3 and 8.
- **Privacy-Invasive Toys:** We alert parents and toy givers to so-called "connected toys" that may violate children's privacy and other consumer protection laws. As more and more products are part of the "Internet of Things," data collection and the sharing of consumer information become greater concerns. As an example, we have included details on VTech's collection of children's data, which was discovered earlier this year.¹ We also highlight the Mozilla Foundation's findings that toys, such as an Amazon kids' tablet, fail to meet the Foundation's minimum privacy and security standards.²

Our 33rd annual *Trouble in Toyland* shows that old hazards continue to find their way onto the marketplace and into the homes of children across the country. We also find new threats from trendy toys with toxic chemicals to smart toys that collect data inappropriately.

Additionally, our report focuses on the need to improve the effectiveness of our recall system. While U.S. PIRG Education Fund didn't find any newly recalled toys that are still being sold online, that does not mean parents have removed recalled toys from their homes. Over the

past 12 months, the CPSC, in cooperation with manufacturers and distributors, has announced more than 40 recalls of toys and children's products totaling over 2.7 million units. Since companies are not required to inform the public of how many of these products are returned to the company or repaired by the company, we have no way of knowing of how effective these recalls have been and how many of those 2.7 million dangerous units are still in the homes of consumers.

No parent should have to be a detective to protect their child's health and safety. Instead, we need to redouble efforts to keep dangerous toys out of the market. Those efforts include:

- **Build on recent progress by strengthening toy safety standards:** Policy-makers should continue to evaluate new threats, such as boron, and ensure the Consumer Product Safety Commission has the funding and authority to protect the public.
- **Protect against new public health threats in toys:** Require toys with boron concentrations above 300 ppm to have a warning label and start a full-scale investigation to determine if limits should be established.
- **Improve recall effectiveness:** Numerous recalled toys are likely still in the hands of children. The CPSC should require companies to track and report the number of items returned, improve efforts to directly notify consumers who purchase dangerous toys, and require sellers to conduct more effective outreach campaigns.
- **Enhance manufacturer and retailer recall practices:** Use advertising data to target likely purchasers with information on the recalls, use purchase data

from rewards program and customer accounts to directly notify purchasers of recalled toys, and meet legal requirements for warning labels on choking hazards.

- **Continue to enforce and improve strong CPSC safety standards:**

- Vigorously enforce the Consumer Product Safety Improvement Act's mandatory standards for toys, including strict limits on lead and lead paint in any toys, jewelry or other articles for children under 12 years;
- Considering our 2017 finding that some fidget spinners have extremely high lead content, classify all fidget spinners as toys and hold them to federal standards for children's products³; and

- Review whether Amazon and Amazon sellers are complying with 16 CFR 1500, which requires choking hazard labels.

While government, manufacturers and sellers have an obligation to protect children from hazardous toys, we continue to find hazards in our annual survey. In light of these ongoing problems, parents and caregivers should also take additional steps to protect children from potential hazards. You can find our full guide of recommendations at ToySafetyTips.org. In addition, parents can subscribe to recall updates at recalls.gov, investigate existing toys at SaferProducts.gov, examine toys carefully prior to and after purchase for potential choking or other hazards and be aware of internet connected toys that may collect information without consent or knowledge of parents.

Introduction

Toys are safer than ever before, thanks to decades of work by product safety advocates, parents, the leadership of Congress, state legislatures and the Consumer Product Safety Commission (CPSC). Nonetheless, from October 2017 to October 2018 the CPSC, in cooperation with manufacturers and distributors, announced over 40 recalls of toys and children's products totaling over 2.7 million units.⁴ In 2016 (the last year for which data are available), there were 240,000 toy-related injuries treated in U.S. hospital emergency departments, and 7 toy-related deaths.⁵

This year is the 33rd annual release of our Trouble in Toyland report. This year, we emphasize three warnings to parents and caregivers:

- Many hazardous toys are still on the market. Our survey of just 40 toys found 6 slime products with dangerously high boron content and several other toys with potential hazards. Also, remember that many items sold online could contain choking hazards - despite no warning being listed.
- Increasingly popular internet-connected toys may imperil the privacy of children and even violate consumer protection laws.

- Recalls are often not effective in reaching consumers. You may have recalled toys at home. We urge you to check our list of recalls published in Appendix 4. Other recalls can be found at toysafety-tips.org or cpsc.gov/recalls.

While the nation has come a long way in the last 30 years in terms of both consumer protection policy and compliance with standards, our findings make it clear that dangerous toys are still slipping through the cracks and into children's hands. And considering the limited nature of our survey, it is possible that other toys violate existing protections - indicating that we need a more aggressive approach to protect the public from these hazards.

The Road to Safer Toys

In the past thirty years, the Trouble in Toyland report has led to over 150 recalls and other actions by manufacturers, retailers, and the CPSC.

Key parts of the Consumer Product Safety Improvement Act (CPSIA), which passed 10 years ago, have significantly improved toy safety by recognizing the growing threat of toxic chemicals.⁶ The act gave CPSC authority to enforce strict limits on lead, other heavy metals, and

phthalates in toys and children's products.⁷ Nevertheless, we highlight in this report how dangerous toxic chemicals and unlabeled choking hazards can still be found in the toy aisle.

Going forward, we are pleased with the progress we have made and will continue to advocate for actions to protect children from new toxics and for improved choking hazard rules. We will also fight against general attacks on consumer protection regulations that affect the CPSC and other agencies.

The Need to Improve Recall Effectiveness

Despite these improvements, making recalls faster and more effective remains a challenge. Not enough consumers hear

about recalls and not enough of those who do take action. This year's report focuses on warning parents and caregivers of the threat posed by recently recalled toys that you may have at home.

We also warn retailers and distributors, as well as resellers, particularly Internet sites, that it is illegal to sell previously recalled products. Most brick and mortar stores have instituted inventory control "lock-outs" that prevent a recalled toy a consumer finds on the shelf from being purchased at the checkout. The CPSC has increased efforts to reach out to second-hand stores and monitor Internet sellers.

While not a toy-related death, an eighth child fatality occurred in May 2017 because of IKEA furniture with a tip-over hazard, well after a recall was instituted in June 2016. The tragedy has drawn new attention to the need for more action on recall effectiveness.⁸

Hazards in Toys

Despite progress in recent years, some toys and children's products still have the potential to cause harm. Depending on the materials used and the quality and nature of the product itself, the risks for children posed by toys and other products range from choking to poisoning. In extreme cases, the consequences can be fatal. This section describes the most common hazards for children, the federal standards relevant to each hazard, and our findings.

Toxic Hazards

Lead

Despite the CPSIA and stronger enforcement by the CPSC, toys containing chemicals that pose a health risk to children continue to make it onto American store shelves.

Lead has a variety of commercial uses including in batteries, plastics, and radiation shielding. In the past, lead was also added to gasoline and paint.⁹ Because of lead's toxicity, in 1978, the U.S. banned lead in household paint, products for children, and dishes and cookware.¹⁰ Lead exposure is particularly damaging for young children because of its impact on development. Even low levels of lead in blood have been shown to undermine IQ, atten-

tiveness, and academic achievement. The Centers for Disease Control and Prevention (CDC) makes clear that any amount of lead in a child's blood is unsafe.¹¹ Moreover, since the effects of lead exposure cannot be reversed, it is especially important to prevent lead exposure to children in the first place.

Unfortunately, lead continues to find its way into American toys whether through lax monitoring or problems with manufacturing here or elsewhere.¹² Additionally, lead may be incorporated into plastic.¹³ Lead is used to soften plastic and make it more flexible, but when the plastic is exposed to sunlight, air, or detergents, the chemical bond between the lead and plastic breaks down, forming lead dust. Children can inhale or come in contact with this dust when they put toys in their mouths.¹⁴ Lead in toys continues to be an issue.

Federal Standards for Lead

With a few exceptions, the applicable federal law requires that all children's products manufactured after August 2011 contain no more than 100 parts per million (ppm) of total lead content in all accessible parts.¹⁵ (The CPSC defines accessible parts as parts that a child could reach through "normal and reasonably foreseeable use and abuse of the product."¹⁶) However, the U.S. Consumer Product Safety Commis-

Figure 1²³

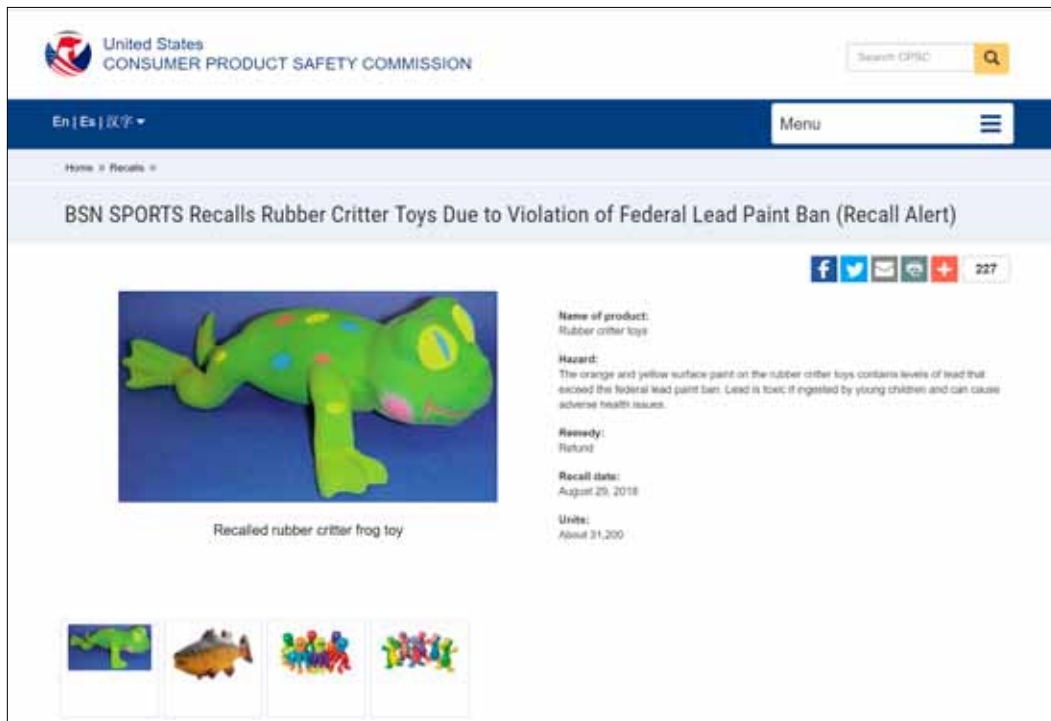

sion describes lead-contaminated paint as “banned.”¹⁷ Despite the “ban” terminology, the law does not require regulatory action for lead contamination below that amount. The exceptions to the limit are listed below:

- Paint or similar surface coatings on all children’s products are subject to a limit of 90 ppm of total lead. (Household paints are also subject to this rule.)
- Exceptions to these standards include metal components of bicycles, which cannot contain more than 300 ppm of lead. Components in electronic devices, some used children’s products, inaccessible parts, and other items are exempt from the lead standard.¹⁸

Note that these limits do not meet the recommendations of the American Academy of Pediatrics (AAP), which recommends that all products intended for use

by children contain no more than trace amounts of lead, defined as 40 ppm, the high end of lead concentrations in uncontaminated soil.¹⁹

Recent Lead-Related Recalls

In August, more than 30,000 units of rubber critter toys were recalled due to lead paint contamination. The CPSC described this recall as occurring “due to violation of [the] federal lead paint ban” in their recall advisory which is pictured in **Figure 1**.²²

This particular recall was announced in the month marking the 10th anniversary of Congress enacting stronger consumer protections for toys and other children’s products, in response to a far larger rash of lead contaminated toys. This new incident of mass lead contamination in toys in 2018 highlights how lead contaminated children’s products are still reaching store shelves and getting into the hands of children.

New Toxic Threats

Boron

Boron compounds have a variety of industrial and consumer uses. Boric acid and various borates (like borax) are commonly used in glass manufacturing, pesticides, antiseptics, and detergents. Additionally, boric acid can be found in certain pharmaceuticals as a pH buffer.²⁴

According to the EPA, “studies in both humans and animals show that boron is readily absorbed from the gastrointestinal tract.”²⁵ Based on case studies, humans are asymptomatic when ingesting small volumes of boron at less than 3.68 ppm. However, at moderate to high doses, boron ingestion can cause nausea and vomiting and may have long-term negative effects on an individual’s reproductive health. For children, the EPA puts the lethal dose of boron between 5 and 6 grams.²⁶ The National Institutes of Health identified similar health effects from ingestion of borax and other boron compounds.²⁷

As of 2008, six states (California, Florida, Maine, Minnesota, New Hampshire and Wisconsin) had established standards or recommendations on boron limits in drinking water - ranging from a limit of .6 ppm to 1 ppm.²⁸ The National Institute for Occupational Safety and Health (NIOSH) has also set limits for worker exposure to boron compounds.²⁹ However, the U.S. has not established official limits on boron in consumer products. For toys, the European Union has set limits on bo-

ron concentration - 300 ppm for sticky/liquid toys and 1200 ppm in “dry, brittle, powder-like or pliable” toys.³⁰

Jordan, Canada, Norway and the United Arab Emirates have already taken action to limit or ban boron content in slime toys like the ones we have identified in the following section of the report.³¹

Toy Survey Findings: Boron

We found slime toys sold to children in the U.S. with boron concentrations as high as 4700 ppm, in the case of “Kangaroos Original Super Cool Slime.” This is more than fifteen times the European Union’s limit for boron in sticky/liquid toys.³²

Consequently, we have asked the U.S. CPSC to explore the need to set limits on concentrations of boron compounds in children’s products such as slime. To keep kids safe, it may be necessary to limit boron content in children’s toys or, at least, explicitly label toys that are high in boron content.

Not all of the slimes that we tested had high boron content, and the ingredient is not necessary to make slime.³³ Many children make slime with do-it-yourself slime kits. We encourage parents to be careful when using these kits - ensuring their child does not ingest the slime or the borax packet. The slimes with high boron content are listed below.

These slimes can be found in a variety of stores, including online at Amazon and at large retailers like Walmart. See Appendix 1 for more details.

Toy	Available At	Test Results
Kangaroos Original Super Cool Slime	Amazon	Boron – 4700 ppm
Kidsco Glow in The Dark Slime	Amazon, Walmart	Boron – 4600 ppm
Toysmith Jupiter Juice Slime	Amazon, Walmart	Boron – 1900 ppm
iBaseToy Fluffy Slime	Amazon	Boron – 1500 ppm
Haniex Soft Magic Crystal Slime	Amazon	Boron – 1400 ppm
Meland Fluffy Slime	Amazon	Boron – 1100 ppm

Choking Hazards

Small parts in toys, small balls, and balloons all present potential choking hazards. From 2001 to 2016, 116 children died from choking on or asphyxiation by a play item, more deaths than from any other kind of toy.³⁴ Toys containing small parts – for example, a miniature comb for a doll’s hair, or small, interlocking construction blocks – may present a choking hazard for children, especially those under the age of three. Younger children are at a stage of childhood development in which mouthing or biting objects is common, increasing the risk that a small toy or component will get lodged in the windpipe.

Small Parts

The CPSC defines a “small part” as anything that fits inside an official choke test cylinder, which has an interior diameter of 1.25 inches and a slanted bottom with a depth ranging from 1 to 2.25 inches (see Figure 2). This cylinder is the approximate size of the fully expanded throat of a child under the age of three. If a toy or part of a toy – including any part that breaks off or separates during “use and abuse” testing – fits completely inside the test cylinder, the product constitutes a choking hazard.³⁵

Federal Standards for Small Parts

- Federal law bans the sale of toys containing small parts if the toy is intended for use by children under the age of three. Small parts are defined as objects that fit within the choke test cylinder pictured in **Figure 2**.
- Toys with small parts intended for children between the ages of three and six years old must include the following explicit choke hazard warning (**Figure 3**) where they are sold.³⁶

Figure 2

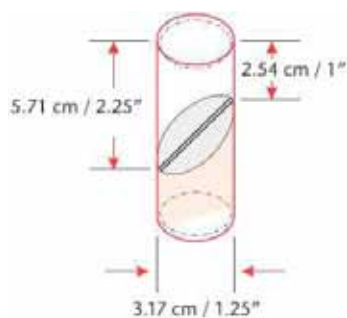

Figure 3



- Bins containing products that may pose a choking hazard are required to post explicit warnings.³⁷ The CPSC uses several factors to determine whether a toy is intended for children under three years old, including the manufacturer’s stated intent; age labeling on the product; the advertising and marketing of the product; and if the toy is “commonly recognized” as being intended for a child under three years.³⁸ A number of items, such as crayons, chalk, modeling clay, and finger paints are exempt from the small parts regulation because they cannot be manufactured in a way that would prevent them from breaking into small parts when subjected to “use and abuse” testing. Children’s clothing and accessories such as shoe lace holders, diaper pins, and barrettes are also exempt because they need to be small to perform their intended purpose.³⁹

Toy Survey Findings: Small Parts

The popular toy L.O.L. Surprise contains small parts that our testing found to be choking hazards. Certain L.O.L. Surprise toys (like “Bundle of LOL Surprise! Pearl Surprise Turquoise and Purple Styles” or “L.O.L. Surprise! Pets Series 4”) are marketed to children younger than 6 but have no choking hazard label on their Amazon listing - seemingly in violation of the labeling requirements and Amazon’s guidelines.⁴⁰ When we inspected the same toys in brick-and-mortar stores, we found that the toy packaging was appropriately labeled.

We found that on Amazon’s website, some models of L.O.L. Surprise are listed as appropriate for ages 5 and up, while very similar models are listed as appropriate for ages 8 and up. This is an important distinction because any toy or game that includes a small part and is intended for children ages 6 and up requires no choking hazard label, and thus the lack of a warning label may be in compliance with the law.⁴¹ However, we see no reason that these toys wouldn’t appeal to five year olds, and in our review, we found no evidence that these toys are marketed to children in different age groups - outside of Amazon’s indexing system.

Additionally, our researchers identified Hatchimals Fabula Forest as a toy with potential choking hazards that is improp-

erly labeled and marketed online. When Hatchimals eggs break open, the eggshell pieces fit the legal definition of “small parts.” The online listing on Walmart.com for the product did not have a choking hazard label, despite being marketed to children under 6 — seemingly in non-compliance with federal law.⁴² **Figure 4** shows the Walmart sales page lacks a warning label.

On Amazon, some models of both L.O.L. Surprise and Hatchimals are marketed to parents of children ages 2 and up (rather than 3 and up) meaning they can be found when a consumer searches for ages 2-4 under “Toys & Games.” This Amazon indexing system appears to bolster the case that these items are intended for children under 3 and, therefore, cannot contain “small parts,” as defined by the law.⁴³

Online marketing for toys is far from a trivial issue. The Toy Association, the trade association for the U.S. toy industry, estimates that 2017 saw approximately \$27 billion dollars in toy sales.⁴⁴ And according to One Click Retail’s “Toys on Amazon: 2017 Review,” Amazon sold an estimated \$4.5 billion worth of toys in the U.S.⁴⁵ With e-commerce on the rise, we believe it is becoming increasingly important that Amazon and other major online retailers, like Walmart.com, adhere to toy safety regulations.

Figure 4⁴⁶

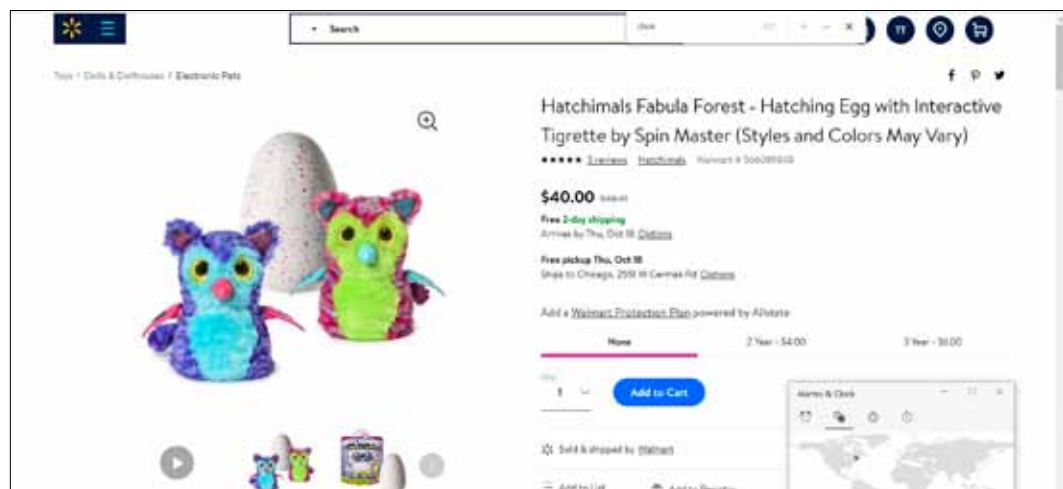

Small Balls

Since 1994, federal law has treated small balls in toys as a distinct choking hazard from small parts, one that is subject to more stringent standards. The law defines a ball as “any spherical, ovoid, or ellipsoidal object designed or intended to be thrown, hit, kicked, rolled, dropped, or bounced.” In addition, “the term ‘ball’ includes any multi-sided object formed by connecting planes into a generally spherical, ovoid, or ellipsoidal shape that is designated or intended to be used as a ball.”⁴⁷ As with small parts, the risk is particularly great for young children inclined to put objects in or near their mouths. From 2001 to 2016, the most recent year for which data are available, small balls and marbles were responsible for 38 choking fatalities in children reported to the CPSC.⁴⁸ U.S. PIRG Education Fund believes that small balls are not the only round toys that are a choke hazard. We recommend that all round, ball-shaped toys pass not just the small parts test but the small ball test, too. Any small, rounded toy, such as items found in toy food sets, can choke a child.

Federal Standards for Small Balls

- Balls with a diameter of less than 1.75 inches (as opposed to small parts which must fit into a cylinder 1.25 inches across) are banned for children younger than three years of age.⁴⁹ Toys that are spherical or have spherical parts, but are not intended for use as a ball, do not have to meet this standard. Any small ball intended for children over the age of three must include the warning in **Figure 5**.⁵⁰

Figure 5

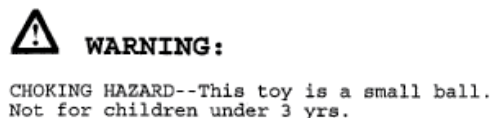

- A toy or game containing a small ball and intended for children between ages three and eight must include the warning in **Figure 6**.⁵¹

Figure 6

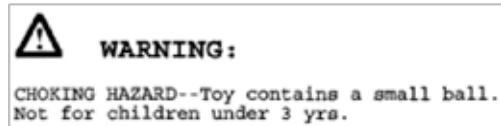

Toy Survey Findings: Small Balls

This year, our researchers found that some L.O.L. Surprises also contain small plastic containers - which meet the legal definition of “small balls”. As indicated in the “Toy Survey Findings: Small Parts” section, some of these items lack choking hazard labeling on their Amazon listing, while some are marketed inconsistently or inappropriately to certain age groups. This is yet another reason why the toy requires a choking hazard warning in its online listing. One verified purchaser on Amazon (**Figure 7**) indicated that they experienced an incident wherein a 9-mo. old child began to choke on the small balls in L.O.L. Surprise! Pearl Surprise.

Figure 7



Balloons

Balloons pose the most serious choking hazard to children in the United States. They are responsible for more childhood deaths by suffocation than any other product. Children can suffocate on balloons by accidentally inhaling while attempting to inflate them, inhaling uninflated balloons while sucking or chewing on them, or inhaling pieces of broken balloons.⁵² Between 2001 and 2016, the most recent year for which data are available, approximately 40% percent of all toy-related choking fatalities reported to the CPSC involved balloons.⁵³ Because balloons are intended for older children, and because of the risks inherent in inflating them, balloons present a serious choking hazard for children significantly older than the typical at-risk population for small parts and balls.

Federal Standards for Balloons

Balloon packages must display an explicit choke hazard warning. Due to the risk balloons pose even to older children, the warning must explain that the hazard applies to children younger than eight.⁵⁴ The required label is shown in **Figure 8**.

Figure 8

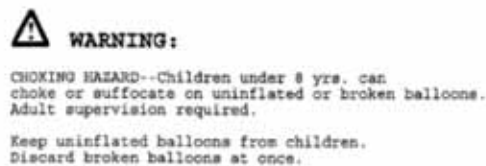

Toy Survey Findings: Balloons

Our researchers discovered a three-fold problem with how balloons are marketed on Amazon:

- When consumers search for toys and games for children from birth-24mo. and ages 2-4, they will find latex balloons listed. However, latex balloons are considered unsafe by the CPSC for chil-

dren under age 8.⁵⁵ When our researchers searched Amazon in October, there were 947 search results for latex balloons that are “Toys & Games” for children from “Birth to 24 months.” There were more than 2000 results for ages 2-4 and more than 1000 results for ages 5-7.

- Our researchers surveyed five search pages for latex balloons on Amazon marketed to children under age 2 and found that 87% of the items lacked a choking hazard warning on the site – potentially violating federal law and Amazon’s guidelines.⁵⁶ Of the items surveyed, none of the latex balloons fulfilled by Amazon had choking hazard labels on the site. Examples of balloons with no choking hazard label at all are listed in Appendix 1.
- When there is a choking hazard warning, it is placed below various advertisements and recommendations positioned on the page by Amazon. A consumer can easily purchase a toy without seeing the warning, particularly with Amazon’s one-click buying feature. The warning is in yellow at the bottom left of **Figure 9**.

Incidents of improper labeling, like the examples in Appendix 1, could be potential violations of federal law and must be corrected by Amazon.

Almost all of the balloon packages we inspected on other major online retailers and in brick-and-mortar stores included the required warning label: complete with language warning that children under eight can choke on balloons and balloon parts. However, we continue to find balloons marketed to children under eight that also include an indication that the product is for children ages 3 and older, or contain a second label with a small parts warning that the balloons are not for children under 3 years. This second label can be confusing because a parent can assume that the balloons can be used by children between 3 and 8 years.

Figure 9

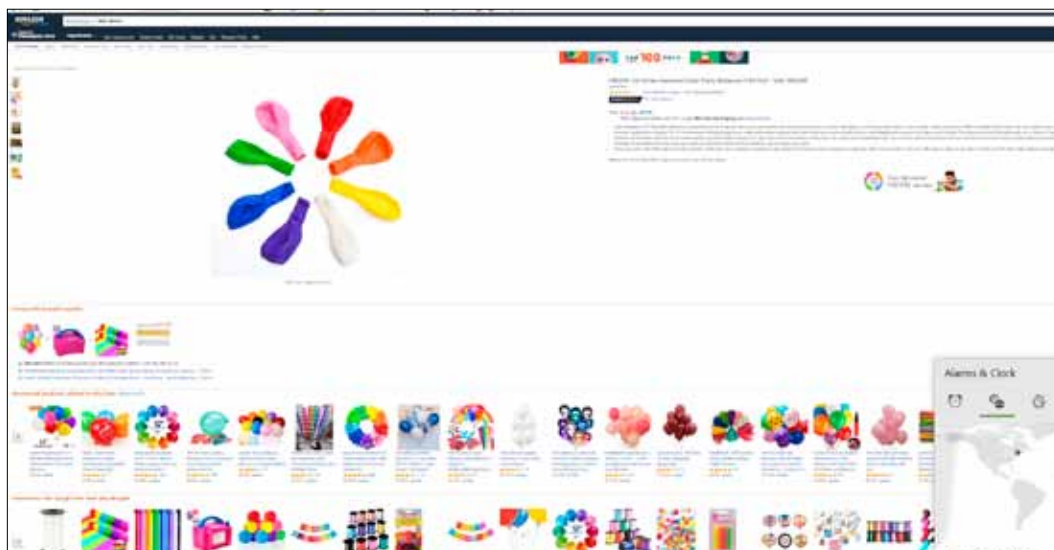

Magnets

Small, powerful magnets that rose to popularity in the mid-to-late 2000s have the potential to cause serious injury and even death due to complications arising from ingestion.⁵⁷ These “rare-earth” magnets are much more powerful than refrigerator magnets. Such magnets are used in various types of toys including construction sets, puzzles, toy jewelry, action figures, board games, and train sets. They are also common in novelty items containing hundreds of small magnetic pieces and previously marketed at adults as sculpture kits, desk toys, or stress relievers. “Buckyballs” – the subject of a recall ordered by the CPSC – are perhaps the most well-known example of such a product, with hundreds of small, spherical magnets, each much smaller than a marble, closer in size to a BB pellet.⁵⁸

Despite being marketed as a desk toy for adults, incidents reported to the CPSC made clear that children were nonetheless suffering serious injury after swallowing these magnets, highlighting the risk posed by adult novelty items even with appropriate warning labels.⁵⁹ What makes these adult magnet sets so dangerous is that their numerous magnets are easy to lose

track of and the products themselves are inherently appealing to children. While very young children may mistake component magnets for candy, older children and young adolescents may use pairs of magnets to imitate facial or tongue piercings, thus putting magnets in a position to be accidentally inhaled or swallowed. Once in the digestive system, a single magnet may pass through the body without incident. If two or more magnets are swallowed, however, their attractive forces can pull them toward each other, causing obstructions or pinching,⁶⁰ or trapping intestinal walls or other digestive tissue.⁶¹ In extreme cases, the magnetic attraction can perforate intestinal walls. In 2013, a 19-month old girl died after seven small magnetic balls perforated her bowel, leading to infection.⁶² Even non-fatal magnet-related injuries are severe. Nearly 80 percent of high-powered magnet ingestions require invasive medical intervention, either through an endoscopy, surgery, or both. In comparison, only 10 to 20 percent of other foreign body ingestions require endoscopic intervention and almost none require surgery.⁶³ Between 2009 and 2013, the CPSC estimates that high-pow-

ered magnets caused approximately 2,900 injuries that required treatment in an emergency room.⁶⁴ A 2014 study of magnet-caused injuries at one large pediatric hospital found a significant increase in their incidence between 2002 and 2012.⁶⁵

Federal Standards for Magnets

In 2018, small powerful magnets are still legal and available, after the Consumer Product Safety Commission's rule prohibiting them was vacated in a decision by the U.S. Court of Appeals for the Tenth Circuit.⁶⁶

- In October 2014, the CPSC adopted a new rule that powerful magnets, whether sold in sets or individually, must be too large to fit into the official small parts cylinder used by the CPSC to determine choke hazards (see “Choking Hazards” section). Magnets that fit into a choke tube and that exceed the CPSC's magnetic flux standards were banned for sale. The ban on small, high-powered magnet sets took effect on April 1, 2015.⁶⁷
- The separate ASTM F963 standard for toys bans loose magnets or magnetic components in toys for children under the age of 14. There is an exception for magnets included in certain “hobby, craft, and science kit-type items” intended for children age eight years and older, provided the products comply with special magnet hazard disclosure requirements.⁶⁸ The severity of injuries caused by small, high-powered magnets led to the CPSC's ban. **However, Zen Magnets successfully challenged the CPSC's ban and the rule was vacated by the 10th Circuit.**⁶⁹

Recommendation: We continue to recommend to all parents that small powerful magnet sets be placed in plastic bags and thrown away.

Smart Toys & Internet-Connected Children's Products

As more and more products become connected to the Internet as part of the “Internet of Things,” data collection, data privacy and the sharing of consumer information become greater concerns. While the collection of and sharing of information about adults and teenagers is lightly regulated in the United States, the collection and subsequent use of information about children under 13 is governed by the Children's Online Privacy Protection Act (COPPA) of 1998. The act is enforced by the Federal Trade Commission (FTC), which has brought 28 actions against websites and firms for COPPA violations.⁷⁰ In June of 2017, the FTC confirmed that “connected toys” are subject to COPPA.⁷¹

Other government agencies have begun to review this issue as well. In July of 2017, the U.S. Federal Bureau of Investigation (FBI) issued a stark warning to parents:

The FBI encourages consumers to consider cyber security prior to introducing smart, interactive, internet-connected toys into their homes or trusted environments. [...] In some cases, toys with microphones could record and collect conversations within earshot of the device. Information such as the child's name, school, likes and dislikes, and activities may be disclosed through normal conversation with the toy or in the surrounding environment. The collection of a child's personal information combined with a toy's ability to connect to the Internet or other devices raises concerns for privacy and physical safety. Personal information (e.g., name, date of birth, pictures, address) is typically provided when creating user accounts. In addi-

tion, companies collect large amounts of additional data, such as voice messages, conversation recordings, past and real-time physical locations, Internet use history, and Internet addresses/IPs.⁷²

The number of connected products grows daily. Websites, mobile apps and products, including children's watches and toys, are all capable of collecting information about and tracking users, including children under 13.

Earlier in the year, we saw a significant example of a children's product that posed privacy problems. The Federal Trade Commission (FTC) charged the electronic toymaker VTech Electronics with collecting personal data on hundreds of thousands of children, without their parents' consent or knowledge.⁷³ Additionally, it was also alleged that a hacker was able to gain access to that collected data in 2015.⁷⁴ VTech agreed to pay \$650,000 to settle charges levied against it by the FTC.⁷⁵

This marks the first case of the FTC challenging an internet-connected toy using the Children's Online Privacy Protection Act.⁷⁶ We believe that companies should give parents the ability to choose when and how their child's personal data is given out. So long as that is not the case, the FTC should continue to pursue these legal challenges.

For the 2018 holiday season, the Mozilla Foundation investigated whether popular toys and games meet their minimum security and privacy standards.⁷⁷ We highlight one toy that failed to meet some of the Mozilla Foundation criteria.

Amazon's popular children's tablet, "Amazon Fire HD Kids Edition," has cer-

tain issues.⁷⁸ The device can share a child's private information with third parties for advertising purposes, and the tablet does not delete the data it stores on you.⁷⁹ The Mozilla Foundation puts it in stark terms: "Amazon gets to know your kid from cradle on."⁸⁰

Parents interested in learning about COPPA can download a free guide -- *Protecting Children's Online Privacy: A Parent's Guide to the new stronger kids' privacy rules for digital media (COPPA)* -- published by the non-profit privacy watchdog, the Center for Digital Democracy.⁸¹

Excessive Noise

Excessive noise can damage the inner ear and cause hearing loss. Sounds can cause harm by being too loud even for a short period of time, or by being loud over an extended timeframe. Hearing loss from excessive noise exposure is common in the U.S., even for the young. An estimated seventeen percent of teens aged 12 to 19 years have some hearing loss for which loud noise could be responsible.⁸² A 1998 study of children in a wider age range found approximately 15 percent of children between ages six and 19 showed signs of hearing loss.⁸³

While the CPSC has not recalled a toy over the past year for noise hazards, excessive noise in toys is of concern because children have the most to lose from hearing loss. Loss of hearing at an early age can affect a child's ability to learn verbal communication skills such as vocabulary and grammar.⁸⁴ This could have consequences for their educational attainment and social and professional success later in life.

Federal Standards for Noise Levels

Noise standards have improved in recent years. Toy manufacturers were not required to follow sound standard guidelines until 2009 when federal law gave the CPSC authority to enforce voluntary standards contained in the comprehensive ASTM F963 toy standard.⁸⁵

- Hand-held, tabletop, floor, and crib toys producing continuous sound cannot do so in excess of 85 decibels when measured from approximately 20 inches.⁸⁶
- Close-to-the-ear toys must adhere to a continuous sound limit of 65 decibels when measured from approximately 20 inches.
- Close-to-the-ear toys are subject to a limit of 96 decibels for bursts of noise when measured from approximately 20 inches.
- All other toys are subject to a limit of 115 decibels for bursts of noise, except toys using an explosive action or percussion cap, which are limited to 125 decibels. As with all sound standards, these are noise levels as measured at approximately 20 inches.

Toy Survey Findings: Excessive Noise

Our researchers discovered one handheld toy that produced continuous sound in excess of 85 decibels in repeated tests – a toy plane manufactured by Haktoys and sold on Amazon, “Haktoys ATS Battery Operated Bump & Go Action F-182 Fighter Jet 8-inch Plane.” We recommend that this toy is tested by the CPSC.

Overheating of Batteries and Chargers

In the United States, burns and fires are significant causes of unintentional deaths and injuries to children.⁸⁷ From October 2017 to October 2018, the CPSC recalled four toys due to overheating that could lead to fire and burn hazards.⁸⁸ Michaels had to recall over 350,000 units of spin art and pottery wheel toys that could overheat or even cause fires.⁸⁹ Fisher-Price recalled over 60,000 of its ‘Soothing Motions Seats’ for the same reason.⁹⁰

Toy Safety Victories

Small Parts Ban (1979)

The CPSC small parts ban prohibited sale of toys or balls intended for children under 3 containing small parts, or that could easily break into parts smaller than a small parts test cylinder.⁹¹

The Child Safety Protection Act of 1994

From 1980-1992, the Consumer Product Safety Commission (CPSC) and Congress did little to protect children from dangerous products. Throughout that period, PIRG and other consumer groups lobbied Congress and the CPSC to increase the size of the small parts choking hazard test and to require appropriate choke hazard warning labels on toys for older children. A 1992 campaign led by ConnPIRG and a number of child safety advocates resulted in a choke hazard warning label law that took effect in Connecticut in 1993. The Connecticut law, upheld in the courts by the state Attorney General, laid the groundwork for a federal standard.

The Consumer Product Safety Improvement Act of 2008

In 2008, after a series of record-breaking toy recalls—including millions of units of lead-laden brand name, iconic toys—Congress passed the Consumer Product Safety Improvement Act (CPSIA), which gave the CPSC broad new powers to speed up recalls and hold toy manufacturers more accountable; the act also set stricter bans on lead, phthalates and other toxic chemicals in children's products. Importantly, the act also required third-party testing of toys at CPSC-approved laboratories and also established a public database, saferproducts.gov, where consumers can file complaints about hazards posed by any CPSC-regulated product, from toys to toasters and electric ranges.

Since 2008 and the passage of the CPSIA, the number of children's products recalled on a yearly basis has continued to decline—whereas before the law, recalls were increasing. This data shows that the CPSIA has had a role in reversing a dangerous trend.

Recommendations

The findings of this year's *Trouble in Toyland* report demonstrate that a lot of work must be done to keep children safe. Various parties need to take significant steps to ensure toy safety. We outline our recommendations below:

Build on recent progress by strengthening toy safety standards: Policymakers should continue to evaluate new threats, such as boron, and ensure the Consumer Product Safety Commission has the funding and authority to protect the public.

Establish new consumer protections: Policymakers should set labeling requirements for toys with high boron content and investigate whether limits need to be set.

Improve Recall Effectiveness: Numerous recalled toys are likely still in the hands of children. The CPSC should take action to require companies to track and report the number of items returned, improve efforts to directly notify consumers that purchase dangerous toys, and require sellers to conduct more effective outreach campaigns. We also recommend that the CPSC:

- Engage in efforts to increase consumer and researcher awareness of the public hazard database SaferProducts.gov;

- Aggressively seek to increase recall effectiveness by requiring sellers to conduct more effective outreach campaigns that stress the real hazard posed, rather than simply promote the purported good will of the firm;
- Perform regular online sweeps checking for the availability of previously-recalled toys; and
- Hold companies reselling recalled products accountable, which also sends a message to others.

To enforce and strengthen safety standards, the CPSC should also:

- Require labeling for children's toys with high boron content and consider setting limits for boron content in children's toys;
- Review whether Amazon is complying with 16 CFR 1500, which requires choking hazard labels;
- Develop revised safety standards for small powerful magnets;
- Revisit lead standards for children's toys to determine if a limit as high as 100 ppm is appropriate;
- Enlarge the small parts test tube to be more protective of children under three;

- Change the small-ball rule to include small round or semi-round objects, and not just “balls” in the strictest definition, since these toys pose the same hazards as small balls (this is especially true of rounded toy food, since it is “intended” to be eaten);
- Conduct decibel testing on the toy plane that we found to be problematic; and,
- Considering our 2017 finding that some fidget spinners have extremely high lead content, classify all fidget spinners as toys and hold them to federal standards for children’s products⁹².

Manufacturers and retailers should improve their recall and safety practices: Use advertising data to target likely purchasers with information on the recalls, use purchase data from rewards program and customer accounts to directly notify purchasers of recalled toys, and meet legal requirements for warning labels on choking hazards. We also recommend that companies:

- Disallow balloons from being marketed to parents of children under age 3;
- Place safety warnings on online listings such that consumers can see the warning without scrolling down, especially given ‘one-click’ purchasing capabilities; and,
- Give parents the ability to choose when and how their child’s personal data is given out.

Parents and caregivers can also take steps to protect children from potential hazards. We recommend that parents:

- Subscribe to email recall updates from the CPSC and other U.S. government safety agencies available at www.recalls.gov;

- Shop with U.S. PIRG Education Fund’s Toy Safety Tips, available at toysafetytips.org;
- Examine toys carefully for hazards before purchase – and don’t trust that they are safe just because they are on a store shelf. Check the CPSC recall database at CPSC.gov before buying toys online;
- Report unsafe toys or toy-related injuries to the CPSC at Saferproducts.gov;
- Remember, toys on our list are presented as examples of previously recalled toys only. Other hazards may exist;
- Review the recalled toys list in this report and compare it to toys in your children’s toy boxes;
- Put small parts, or toys broken into small parts, out of reach. Regularly check that toys appropriate for your older children are not left within reach of children who still put things in their mouths;
- Eliminate small powerful magnets from your home and place small powerful magnet sets that are potentially hazardous in plastic bags before throwing them away; and
- Be aware that that toys connected to the Internet, as well as apps and websites, may be collecting information about children inappropriately. Learn more about the Children’s Online Privacy Protection Act (COPPA).
- Download the free guide – “Protecting Children’s Online Privacy: A Parent’s Guide to the new stronger kids’ privacy rules for digital media (COPPA)” — published by the non-profit privacy watchdog, the Center for Digital Democracy.

Methodology

Recalled Toys

We generated the list of recalled toys from the Consumer Product Safety Commission's database of recalled toys.⁹³ We searched for recalled products from October 2017 to October 2018 and identified items that could be toys if they are meant for use by children or would be gifted to children. We then looked for the toys through online vendors by searching for them on Internet stores and websites. For the toys we were able to buy, we checked the products to determine if they appeared to be part of the recalled batch. We found no toys that could be sourced to a recalled batch at the time of the report.

Toxic Hazards

To test toys for toxic chemicals, U.S. PIRG Education Fund staff purchased dozens of toys that are sold on Amazon and Walmart.com. These toys were all tested by a CPSC-accredited laboratory. The toys that tested positive were then re-tested a second time to confirm the results. While the high content of boron we discovered in children's toys doesn't currently violate the law, it is a clear public health concern that should worry consumers and require policy action to protect public health.

Choking hazards

We examined toys for potential choking hazards, looking for the following problems:

1. A toy labeled for children under three containing small parts or breaking easily into small parts.
2. A toy containing small parts or small balls but intended for children under three.
3. A toy containing small parts or small balls and intended for children over three, but lacking the statutory choke hazard warning or having a choke hazard warning that is obscured or too small.
4. A toy intended for children under six years that lacks the statutory choke hazard warning and appears to fail the "use and abuse" test, breaking easily into small parts that fit in the choke tube.

We relied on labeling guidelines in ASTM F963-11 to assess compliance with labeling standards. For determining the age of children to whom a particular toy is marketed, we used the CPSC's Age Determination Guidelines regarding size, weight, theme, realism, colors, and level of skill.

Noise Testing

For each toy, we conducted three trials on each toy as follows:

- Tested in a location with ambient noise below 45 decibels.
- Measured 20 inches between the measuring tip of our sound meter (Extech 407730 Digital Sound Level Meter 40-130dB) and the toy;
- Turned the toy on and held it in place;
- Ensured that the decibel meter is on the appropriate settings (settings are “Fast”, “Auto”, and “A”);
- Started a silent 30 second timer;
- Recorded sound for 30 seconds with the Extech sound meter; and,
- Documented the highest value recorded by the sound meter during the testing period.

Appendix 1. Potentially Hazardous Toys

Boron

Toy	Test Results	Store
<p>Kangaroos Original Super Cool Slime "Kangaroos Original Super Cool Slime (3-pack)" Model KM-10028-(3)-222</p>	<p>Boron – 4700 ppm</p>	<p>Amazon</p>
<p>Kidsco Glow in The Dark Slime "Kidsco Glow in The Dark Slime - 6 Pack - Assorted Neon Colors - Great Toy for Any Child Favor, Gift, Birthday"</p>	<p>Boron – 4600 ppm</p>	<p>Amazon, Walmart</p>
<p>Toysmith Jupiter Juice Slime "Toysmith Jupiter Juice Slime Green, Yellow, Pink, Purple & Orange Complete Gift Set Party Bundle - 5 Pack"</p>	<p>Boron – 1900 ppm</p>	<p>Amazon, Walmart</p>
<p>iBaseToy Fluffy Slime "iBaseToy Fluffy Slime 8.5 oz Jumbo Foam Slime Soft Non-sticky Stretchy Toys with Non-Toxic Material Fluffy Texture, Toys for Kids and Adults - 4 PACK"</p>	<p>Boron – 1500 ppm</p>	<p>Amazon</p>
<p>Haniex Soft Magic Crystal Slime "Haniex Soft Magic Crystal Slime Clay DIY Toy 12 Containers 1 Pack"</p>	<p>Boron – 1400 ppm</p>	<p>Amazon</p>
<p>Meland Fluffy Slime (4 colors) "Meland Fluffy Slime 7 OZ Jumbo Fluffy Floam Slime Stress Relief Toy, Scented Sludge Toy for Kids and Adults, Super Soft and Non-Stick, ASTM Certified, 4 colors"</p>	<p>Boron – 1100 ppm</p>	<p>Amazon</p>

Choking Hazard: Small Parts & Small Balls

Product Name	Hatchimals Fabula Forest; Hatching Egg with Interactive Tigrette by Spin Master
Type of Hazard	Small parts - choking hazard
Label	Walmart lists the product as appropriate for ages 5-12, but no choking hazard label is present at all on Walmart.com.
Why Toy Is a Hazard	The eggshell pieces are hazards, according to the CPSC's standard for a small part.
Manufacturer/Distributor	Spin Master
Item # (if known)	20074819
Store	Amazon, Walmart
Price Paid	\$44.98 (Amazon), \$40 (Walmart)

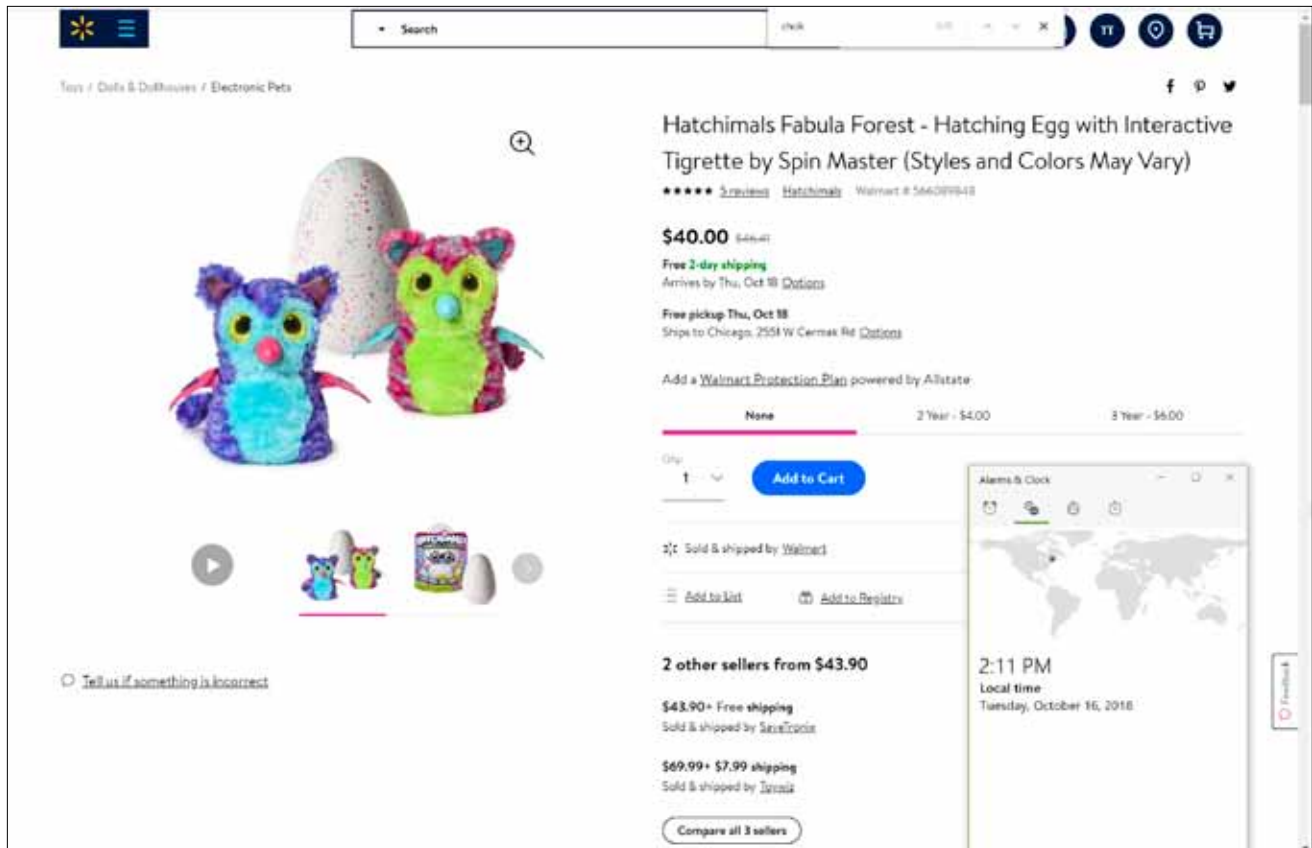

Product Name	Bundle of LOL Surprise! Pearl Surprise Turquoise and Purple Styles
Type of Hazard	Small parts - choking hazard
Label	The toy's physical packaging appropriately labels the toy as dangerous for children under 3, but it's indexed for children as young as 2 on Amazon. Further, Amazon lists the manufacturer recommended age as 4. Additionally, no choking hazard label is present at all on Amazon - despite labels being required for items intended for children under 6 that present a choking hazard.
Why Toy Is a Hazard	The accessory pieces are unsafe, based on the CPSC's standard for a small part. Additionally, the ball pieces are hazards, according to the CPSC's standard for a small ball.
Manufacturer/Distributor	MGA Entertainment
ASIN (if known)	B07BDFR5NC
Store	Amazon (unbundled products can be found at Walmart, Target, and other major retailers)
Price Paid	\$29.88



Choking Hazard: Balloon Examples

Product Name	Examples of Latex Balloons Sold Online as Toys for Children Age 0-2
Label on Toy	No choking hazard label at all and marketed to children under the age of 3. This problem persists in other age brackets, below age 8.
Type of Hazard	Choking – balloon
Why Toy Is a Hazard	Balloons are dangerous for children under 8, according to the CPSC. These balloons, however, are marketed as toys for children under 2 and have no choking hazard label at all. When our researchers searched in October, there were 947 search results for latex balloons that are “Toys & Games” for children from “Birth to 24 months.” There were more than 2000 results for ages 2-4 and more than 1000 results for ages 5-7.
Store	Amazon

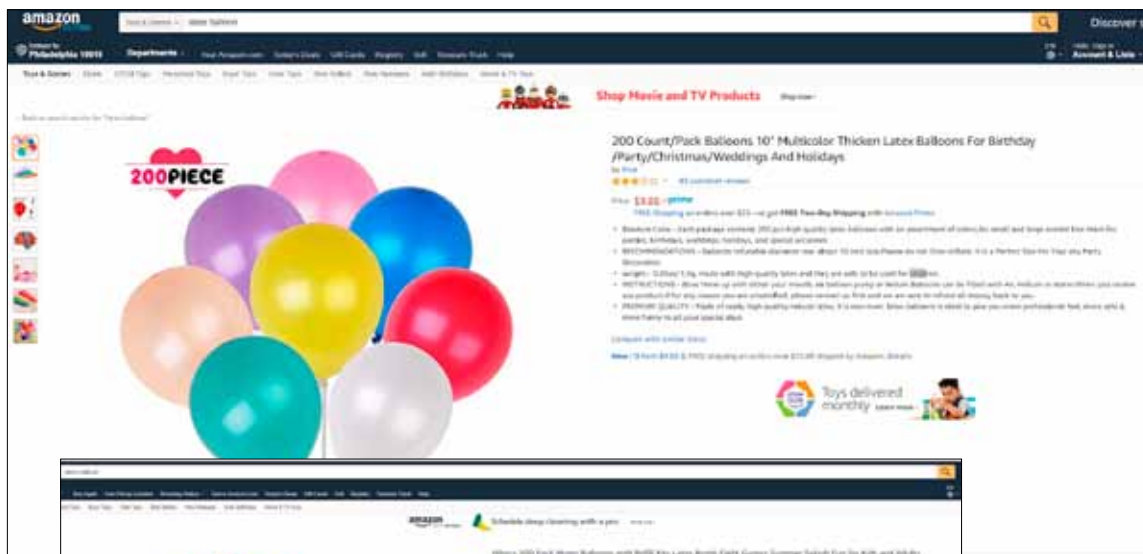

Product Name	Mega Value Pack 14 Latex Punch Balloons
Label on Toy	Statutory balloon warning (Children under 8 can suffocate), the statutory small parts warning (not for children under 3), and a 3+ label.
Type of Hazard	Choking – balloon
Why Toy Is a Hazard	Balloons are dangerous for children under 8, but this package is also labeled for 3+.
Manufacturer/Distributor	Amscan
Item # (if known)	392656
Store	Party City
Price Paid	\$5.99



Appendix 2. Reported Toy-Related Deaths, 2001-2016

Toy-Related Deaths Reported to the CPSC in Children Younger than 15, 2001-2016⁹⁴

	2001	2002	2003	2004	2005	2006	2007	2008	2009	2010	2011	2012	2013	2014	2015	2016	2001-2016 total
Choking/ Asphyxiation																	
Balloons	4	3	3	3	2	3	4	2	2	5	5	3	2	3	1	1	46
Small Balls	1	2	5	4	9	4	5	2	0	3	0	1	1	0	0	1	38
Toy or Toy Part	3	3	3	2	0	5	1	1	2	2	0	3	4	2	1	0	32
Sub-total	8	8	11	9	11	12	10	5	4	10	5	7	7	5	2	2	116
Riding Toys, Scooters, Tricycles	13	5	0	5	8	11	8	10	8	1	5	7	2	8	5	3	99
Toy Boxes	2	0	0	0	0	0	0	1	1	2	1	0	NA	NA	NA	NA	7
Other	2	0	0	8	7	5	6	9	4	6	8	1	3	3	4	2	68
Total	25	13	11	22	26	28	24	25	17	19	19	15	12	16	11	7	290
% of Deaths from Choking/Asphyxia	32%	62%	100%	41%	42%	43%	42%	20%	24%	53%	26%	47%	58%	31%	18%	28%	40%

Appendix 3. CPSC Characteristics of Toys for Children Under Three

The CPSC looks at whether toys are marketed to children under the age of three and whether the toys follow some general characteristics that make toys appealing to children under three, which are listed here⁹⁵:

Size and Weight: Small and lightweight, easy to handle.

Theme: Represents a common object found around the home, farm, or neighborhood.

Degree of Realism: Silly or cute, some realistic details.

Colors: Bright, contrasting colors covering large areas of the toy.

Noisemaking: Not loud or frightening.

Action and Movement: May be silly, should be easy for child to cause movement.

Type and level of skill: Lets child begin to learn skills or practice skills such as walking, stacking, and sorting; should be slightly beyond child's capabilities to maintain interest.

Appendix 4. CPSC-Recalled Toys from October 5, 2017 to October 26, 2018

Name of Toy	Hauck Nerf® Battle Racer Go-Karts
Distributor	Hauck Fun For Kids, Inc., of Ontario, Canada
Original Dates of Sale	January 2016 through March 2017
Original Price before Recall	\$200-300
Why Toy Is a Hazard	The steering wheel on the go-kart can detach, break or crack while in use, posing a laceration and/or collision hazard to young children.
Remedy	Consumer should immediately stop using the recalled go-karts and contact Hauck for a new steering wheel.
How to Tell if Your Toy Might Have Been Recalled	The model number T91869, and the date of manufacture is printed on a white sticker located on the underside of the seat. Only go-karts with a date of manufacture between 01/2016 and 03/2017 are being recalled.
CPSC Recall Website	https://www.cpsc.gov/Recalls/2018/hauck-fun-for-kids-recalls-gokarts-due-to-laceration-and-collision-hazards
Recall Date	05/08/2018
Number of Units Recalled	26,300
Incidents/Injuries	Hauck has received 639 reports in the United States of the steering wheel detaching, breaking or cracking with one resulting in a laceration to a child's face requiring stitches and one resulting in a minor scrape to a child's chest.



Name of Toy	Munchkin Waterpede™ Children's Bath Toys
Importer	Munchkin Inc., of Van Nuys, Calif.
Original Dates of Sale	September 2015 – January 2018
Original Price Before Recall	\$5 - \$7
Why Toy Is a Hazard	The bath toy can break apart exposing small parts, posing a choking hazard to young children.
Remedy	Consumers should immediately take the bath toy away from young children and contact Munchkin for a free replacement bath toy of comparable value.
How to Tell if Your Toy Might Have Been Recalled	All the toys fitting the above description are subject to the recall.
CPSC Recall Website	https://www.cpsc.gov/Recalls/2018/Munchkin-Recalls-Waterpede-Bath-Toys-Due-to-Choking-Hazard
Recall Date	05/10/2018
Number of Units Recalled	72,000
Incidents/Injuries	The firm has received one report of the toy breaking apart and exposing small beads. No injuries have been reported.



Name of Toy	Michaels Creatology® Spin Art Kits
Distributor	Michaels Stores Procurement Co. Inc. (MSPCI), a subsidiary of The Michaels Companies Inc., of Irving, Texas
Original Dates of Sale	August 2011 – February 2018
Original Price Before Recall	\$25
Why Toy Is a Hazard	The battery compartment in the spin art kit can overheat, posing fire and burn hazards.
Remedy	Consumers should immediately take the recalled spin art kits away from children, stop using them and return them to any Michaels store for a full refund.
How to Tell if Your Toy Might Have Been Recalled	This recall involves spin art kits sold under the Michaels private brand Creatology®. The 34-piece kit includes one battery operated spin art wheel with cover, paint, paint brushes, and paper. The recalled art kits are blue and have SKU number 197861 and one of the following UPC codes printed on the barcode on the box: 042409093252, 042409930601, 042409093115, 042409093061, 042409931141, 069545093113, 400100663486
CPSC Recall Website	https://www.cpsc.gov/Recalls/2018/michaels-recalls-spin-art-kits-due-to-fire-and-burn-hazards
Recall Date	05/17/2018
Number of Units Recalled	110,000
Incidents/Injuries	The firm has received two reports of battery compartments overheating in the spin art kits. No injuries have been reported.



Name of Toy	Michaels Creatology® Pottery Wheel Kits
Distributor	Michaels Stores Procurement Co. Inc. (MSPCI), a subsidiary of The Michaels Companies Inc., of Irving, Texas
Original Dates of Sale	August 2011 – February 2018
Original Price Before Recall	\$25
Why Toy Is a Hazard	The battery compartment in the pottery wheel kit can overheat, posing fire and burn hazards.
Remedy	Consumers should immediately take the recalled pottery wheel kits away from children, stop using them and return them to any Michaels store for a full refund.
How to Tell if Your Toy Might Have Been Recalled	The recalled pottery wheel kits are blue and have SKU number 078859 and one of the following UPC codes printed on the barcode on the back of the box: 0400100663462, 0042409006603, 0042409006702, 0042409006757, 0069545670017, or 0886946767692.
CPSC Recall Website	https://www.cpsc.gov/Recalls/2018/Michaels-Recalls-Pottery-Wheel-Kits-Due-to-Fire-and-Burn-Hazard
Recall Date	05/17/2018
Number of Units Recalled	263,000
Incidents/Injuries	The firm has received one report of overheating, and one report of a fire in the battery compartment in the pottery wheel kits. No injuries have been reported.



Name of Toy	My First Porsche - Wooden Cars
Importer	Porsche Cars North America Inc., of Atlanta, Ga.
Original Dates of Sale	April 2015 – March 2018
Original Price Before Recall	\$25
Why Toy Is a Hazard	The wheels and axles can detach from the wooden toy car, posing a choking hazard to young children.
Remedy	Consumers should immediately stop using the recalled toy cars, take them away from young children and contact a local authorized Porsche dealer to return the recalled toy car and receive a full refund.
How to Tell if Your Toy Might Have Been Recalled	The underside of the toy has "BAJO" and a lot number printed on it. The following lot numbers are included in this recall: 011215, 020916, 031017, 031114, 031116, 040116, 040416, 040516, 041217, 051015, 061117, or 090915.
CPSC Recall Website	https://www.cpsc.gov/Recalls/2018/Porsche-Recalls-Toy-Cars-Due-to-Choking-Hazard#
Recall Date	05/22/2018
Number of Units Recalled	1,700 (In addition: 330 were sold in Canada)
Incidents/Injuries	None reported.



Name of Toy	Petit Collage Musical Jumbo Wooden Xylophones
Importer	Petit Collage, of San Francisco, Calif.
Original Dates of Sale	August 2017 – February 2018
Original Price Before Recall	\$24
Why Toy Is a Hazard	The ball on the end of the toy xylophone beater stick can separate, posing a choking hazard to young children.
Remedy	Consumers should immediately take the recalled toy xylophone beater sticks away from children, stop using them and contact Wild & Wolf for a free replacement beater stick.
How to Tell if Your Toy Might Have Been Recalled	“Petit Collage” and “TT.1902.0617” are printed on the bottom back of the xylophone. Only xylophones with this letter/number combination are included in the recall.
CPSC Recall Website	https://www.cpsc.gov/Recalls/2018/Wild--Wolf-Recalls-Petit-Collage-Childrens-Toy-Xylophones-Due-to-Choking-Hazard
Recall Date	04/19/2018
Number of Units Recalled	2,900 (In addition: about 240 were sold in Canada)
Incidents/Injuries	The firm has received one report of the ball separating from the beater rod and one report of the ball being loose. No injuries have been reported.



Name of Toy	Pull-Back Speedy Jets
Importer/Distributor	The Manhattan Toy Company LLC, of Minneapolis, Minn.
Original Dates of Sale	August 2017 through June 2018
Original Price Before Recall	\$8
Why Toy Is a Hazard	The rubber tires can separate from the wheels, posing a choking hazard for young children.
Remedy	Consumers should immediately take the recalled toy away from children and return it to the store where purchased or contact Manhattan Toy for a full refund.
How to Tell if Your Toy Might Have Been Recalled	The model number and lot code are printed on the bottom of the plane. The recall only includes toy planes with lot code 155400 EJ.
CPSC Recall Website	https://www.cpsc.gov/Recalls/2018/Manhattan-Toy-Recalls-Toy-Planes-Due-to-Choking-Hazard
Recall Date	08/23/2018
Number of Units Recalled	5,100
Incidents/Injuries	The firm has received two reports of the rubber tires separating from the wheels. No injuries have been reported.



Name of Toy	'Totally Me!' Clay Craft Kits
Importer/Distributor	Toys "R" Us Inc., of Wayne, N.J.
Original Dates of Sale	January 2017 through October 2017
Original Price before Recall	\$10
Why Toy Is a Hazard	Mold can be present in the clay, posing a risk of respiratory or other infections in individuals with compromised immune systems, damaged lungs or an allergy to mold.
Remedy	Consumers should immediately stop using the recalled craft kits and return them to Babies "R" Us or Toys "R" Us for a full refund or store credit.
How to Tell if Your Toy Might Have Been Recalled	Model number AD11244 is printed on the bottom of the box. The "totally me!" logo is printed on the front of the craft kit box.
CPSC Recall Website	https://www.cpsc.gov/Recalls/2018/ToysRUs-Recalls-Clay-Craft-Kits-Due-to-Risk-of-Mold-Exposure-Sold-at-BabiesRUs-and-ToysRUs
Recall Date	11/29/2017
Number of Units Recalled	6,000
Incidents/Injuries	The firm has received three reports of mold in the clay. No injuries have been reported.



Name of Toy	Rubber Critter Toys
Importer/Distributor	BSN SPORTS LLC, of Farmers Branch, Texas
Original Dates of Sale	February 2017 – June 2018
Original Price before Recall	\$10 for an individual rubber critter and up to \$145 for a set
Why Toy Is a Hazard	The orange and yellow surface paint on the rubber critter toys contains levels of lead that exceed the federal lead paint ban. Lead is toxic if ingested by young children and can cause adverse health issues.
Remedy	Consumers should immediately take the recalled rubber critter toys away from children and contact BSN SPORTS for a merchandise credit. BSN SPORTS is contacting all known purchasers directly.
How to Tell if Your Toy Might Have Been Recalled	The recall affects products bought between February 2017 and June 2018.
CPSC Recall Website	https://www.cpsc.gov/Recalls/2018/BSN-SPORTS-Recalls-Rubber-Critter-Toys-Due-to-Violation-of-Federal-Lead-Paint-Ban-Recall-Alert
Recall Date	8/29/2018
Number of Units Recalled	31,200
Incidents/Injuries	None reported.



Name of Toy	PlanToys Baby Gym
Importer/Distributor	PlanToys Inc., of Union City, Calif.
Original Dates of Sale	September 2016 – May 2017
Original Price before Recall	\$50
Why Toy Is a Hazard	Babies can strangle on the side rope crossbars on the baby gyms.
Remedy	Consumers should immediately stop using the baby gyms and contact PlanToys for a free replacement baby gym.
How to Tell if Your Toy Might Have Been Recalled	The manufacturing date code TH 080116 through TH 082916 is printed on the top corner joint connecting ball.
CPSC Recall Website	https://www.cpsc.gov/Recalls/2018/PlanToys-Recalls-Baby-Gyms
Recall Date	10/25/2017
Number of Units Recalled	500
Incidents/Injuries	None reported

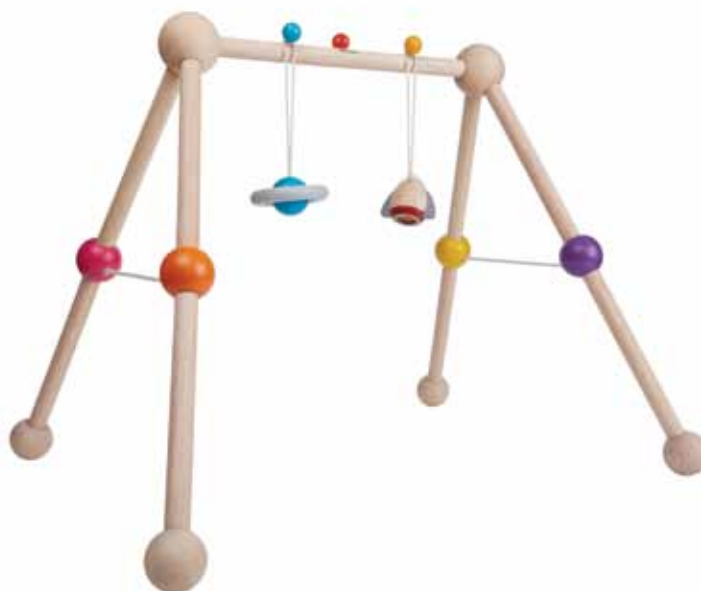

Name of Toy	Toys R Us Bruin Infant Wiggle Ball Toys
Importer	Toys "R" Us Inc., of Wayne, N.J.
Original Dates of Sale	June 2016 through January 2017
Original Price before Recall	\$13
Why Toy Is a Hazard	The wiggle ball's rubber knobs and plastic back can detach, posing a choking hazard to infants.
Remedy	Consumers should immediately discard the recalled balls.
How to Tell if Your Toy Might Have Been Recalled	The recalled wiggle balls have model number 5F6342E and Toys "R" Us printed on the product.
CPSC Recall Website	https://www.cpsc.gov/Recalls/2018/Toys-R-Us-Recalls-Infant-Wiggle-Balls
Recall Date	10/5/2017
Number of Units Recalled	29,700 (about 3,000 were sold in Canada)
Incidents/Injuries	The firm has received six reports of rubber knobs breaking off, including four reports of pieces of the product found in children's mouths.



Name of Toy	Wind-up Musical Toys
Importer/Distributor	Kids Preferred LLC., of East Windsor, N.J.
Original Dates of Sale	January 2016 through August 2017
Original Price before Recall	\$11 - \$20
Why Toy Is a Hazard	The metal post and/or handle of the wind-up mechanism can detach, posing a choking hazard to young children.
Remedy	Consumers should immediately stop using the recalled toys, take them away from young children and contact Kids Preferred for a free replacement toy.
How to Tell if Your Toy Might Have Been Recalled	This recall applies to multiple models of distinctly branded toys. For more information on the brands and the model numbers (which are printed on the smallest white sewn-in label behind the care label) follow the link below:
CPSC Recall Website	https://www.cpsc.gov/Recalls/2018/Kids-Preferred-Recalls-Wind-Up-Musical-Toys
Recall Date	10/19/2017
Number of Units Recalled	587,000 (In addition: about 1,000 were sold in Canada)
Incidents/Injuries	The firm has received six reports of parts from the wind-up handle detaching from the toy. No injuries have been reported.



Name of Toy	Dr. Brown's Lovey Pacifier & Teether Holders
Importer/Distributor	Handi-Craft Company, of St. Louis, Mo
Original Dates of Sale	August 2015 – March 2018
Original Price before Recall	\$10
Why Toy Is a Hazard	The snap can detach from the pacifier ribbon, posing a choking hazard for young children.
Remedy	Consumer should immediately take the recalled holders away from young children and contact Handi-Craft for further instructions to receive a replacement product or comparable merchandise of equal or lesser value.
How to Tell if Your Toy Might Have Been Recalled	Only holders with the following lot codes are included in this recall: RICH0615; RICH0715; RICH0815; RICH1215; RICH0516; RICH0616; RICH0716; RICH1116; RICH1016; RICH0916; RICH1216; RICH0317; RICH0417; RICH0517; RICH0617; RICH0717; RICH0817; RICH0917.
CPSC Recall Website	https://www.cpsc.gov/Recalls/2018/Handi-Craft-Recalls-Dr-Browns-Lovey-Pacifier-Teether-Holders-Due-to-Choking-Hazard
Recall Date	03/15/2018
Number of Units Recalled	590,000
Incidents/Injuries	The firm has received a total of 67 reports of the ribbon fraying and the snap detaching. No injuries have reported.



Name of Toy	Playtime Pals Pop-Up Hideaway Hut Children's Tents
Importer/Distributor	Jewett Cameron Company, of North Plains, Ore.
Original Dates of Sale	November 2017
Original Price before Recall	\$13
Why Toy Is a Hazard	The fiberglass rod that supports the tent can break, splinter and become sharp, posing a laceration hazard to consumers.
Remedy	Consumers should immediately stop using the recalled tents and return them to Home Depot for a full refund or store credit.
How to Tell if Your Toy Might Have Been Recalled	All tents manufactured under this brand have a fiberglass rod that springs to deploy the tent to shape and provides the support for the nylon shell. These items have all been recalled.
CPSC Recall Website	https://www.cpsc.gov/Recalls/2018/Cameron-Company-Recalls-Childrens-Tents-Due-to-Laceration-Hazard-Sold-Exclusively-at-Home-Depot
Recall Date	3/14/2018
Number of Units Recalled	84,000
Incidents/Injuries	The firm has received 270 reports of tent rods breaking, including two reports of bruises and lacerations.



Name of Toy	Children's eWagons
Importer	Radio Flyer Inc., of Chicago, Ill.
Original Dates of Sale	August 2017 – January 2018
Original Price before Recall	\$350
Why Toy Is a Hazard	Improper wiring can activate the wagon's motor unintentionally, posing an injury hazard.
Remedy	Consumers should immediately stop using the recalled wagons and contact Radio Flyer for a full refund.
How to Tell if Your Toy Might Have Been Recalled	Only wagons with model number 3912/3912A are included in this recall. The model number can be found on the handle warning label located near the pivoting joint.
CPSC Recall Website	https://www.cpsc.gov/Recalls/2018/Radio-Flyer-Recalls-Electric-Wagons-Due-to-Injury-Hazard#
Recall Date	3/14/2018
Number of Units Recalled	5,000
Incidents/Injuries	The firm has received two reports of the wagon's motor activating unintentionally. No injuries have been reported.



Name of Toy	Lights & Lullabies Travel Mobiles
Manufacturer	VTech Electronics North America LLC, of Arlington Heights, Ill.
Original Dates of Sale	February 2017 – November 2017
Original Price before Recall	\$25
Why Toy Is a Hazard	The clamp attaching the mobile to the crib rail can break causing the mobile to fall, posing an injury hazard to an infant in the crib.
Remedy	Consumers should immediately stop using the recalled mobiles and contact Vtech for a full refund or a replacement product.
How to Tell if Your Toy Might Have Been Recalled	The recalled mobiles were sold in blue and pink. The model numbers are 80-503000 (blue) and 80-503050 (pink). The model numbers are printed on the battery compartment door.
CPSC Recall Website	https://www.cpsc.gov/Recalls/2018/VTech-Recalls-Lights-Lullabies-Travel-Mobiles-Due-to-Injury-Hazard
Recall Date	1/25/2018
Number of Units Recalled	37,000
Incidents/Injuries	Vtech has received six reports of the clamp cracking. No injuries have been reported.



Name of Toy	Shake & Sing Elephant Rattles
Importer	VTech Electronics North America LLC, of Arlington Heights, Ill.
Original Dates of Sale	November 2015 – November 2017
Original Price before Recall	\$8
Why Toy Is a Hazard	The ears on the elephant rattles can break off, posing a choking hazard to young children.
Remedy	Consumers should immediately stop using the recalled rattles and contact VTech for a full refund or credit for a replacement product.
How to Tell if Your Toy Might Have Been Recalled	VTech is stamped on the elephant. The rattle is about seven inches long and the number 1848 is printed on the back of the rattle adjacent to the battery door.
CPSC Recall Website	https://www.cpsc.gov/Recalls/2018/VTech-Recalls-Infant-Rattles-Due-to-Choking-Hazard
Recall Date	01/25/2018
Number of Units Recalled	280,000
Incidents/Injuries	Vtech has received five reports of the ears breaking off of the rattle. No injuries have been reported.



Name of Toy	Fidget Spinner Keychains
Importer	Fashion Accessory Bazaar, of New York, N.Y.
Original Dates of Sale	September 2017 – November 2017
Original Price before Recall	\$7 - \$10
Why Toy Is a Hazard	The center post on the fidget spinner can become loose or fall out, posing a choking hazard.
Remedy	Consumers should immediately stop using the recalled keychains and contact Fashion Accessory Bazaar for instructions on how to receive a full refund.
How to Tell if Your Toy Might Have Been Recalled	The CPSC provides no clear guidance for this item. Sold at Bonita Marie Int., Gamestop, Wonderland stores and others nationwide and online at Amazon.com and other websites from September 2017 through November 2017 for between \$7 and \$10.
CPSC Recall Website	https://www.cpsc.gov/Recalls/2018/Fashion-Accessory-Bazaar-Recalls-Fidget-Spinner-Keychains-Due-to-Choking-Hazard
Recall Date	1/24/2018
Number of Units Recalled	20,000
Incidents/Injuries	None reported



Name of Toy	BCI Burke Merge Metal Climbers
Manufacturer/Distributor	BCI Burke Company, of Fond du lac, Wis.
Original Dates of Sale	November 2015 – March 2018
Original Price before Recall	\$1400
Why Toy Is a Hazard	The two welded handgrip locations at the top of the climbers can be too large creating a strangulation hazard. A child’s body could become lodged in these openings, posing a strangulation hazard.
Remedy	Consumers should immediately remove these climbers from use and contact the firm for a free repair kit. BCI Burke is contacting all owners directly by mail.
How to Tell if Your Toy Might Have Been Recalled	The metal climbers were sold in many color combinations with small geometric shaped openings with a platform and two welded handgrips at the top. “Burke” is printed on identification labels that are placed on the exterior of the entire play structure.
CPSC Recall Website	https://www.cpsc.gov/Recalls/2019/Metal-Playground-Climbers-Recalled-by-BCI-Burke-Due-to-Strangulation-Hazard-Recall-Alert
Recall Date	10/4/2018
Number of Units Recalled	200
Incidents/Injuries	None reported

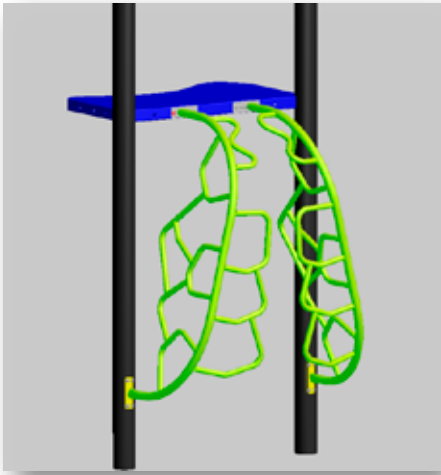

Name of Toy	Mason & Billy Action Dolls
Importer	Boy Story LLC, of Tampa, Fla.
Original Dates of Sale	December 2016 - May 2018
Original Price before Recall	\$100
Why Toy Is a Hazard	The joints on the vinyl dolls can break, creating broken pieces that pose a choking hazard to young children.
Remedy	Consumers should immediately take the recalled dolls away from children and contact Boy Story LLC for instructions on how to receive a full refund of the purchase price.
How to Tell if Your Toy Might Have Been Recalled	This recall involves four styles of Boy Story action dolls. They include the Mason and Billy Action Dolls, and the Mason and Billy HeForShe Special Edition Action Dolls. The recalled dolls are vinyl and measure 4 inches long by 7 inches wide by 18 inches high. They also came with outfits consisting of a button-up shirt, white t-shirt and jeans. Boy Story LLC is stamped on the left foot of each doll.
CPSC Recall Website	https://www.cpsc.gov/Recalls/2018/Boy-Story-Recalls-Action-Dolls-Due-to-Choking-Hazard
Recall Date	9/28/2018
Number of Units Recalled	8,500
Incidents/Injuries	Boy Story has received about 32 reports of the vinyl breaking on the joints. No injuries have been reported.



Name of Toy	Nickelodeon PAW PATROL Deluxe Marshall Hat with Flashlight
Manufacturer/Distributor	Spencer Gifts, LLC of Egg Harbor Twp, N.J.
Original Dates of Sale	September 2015 - November 2017
Original Price before Recall	\$13
Why Toy Is a Hazard	The batteries in the flashlight can overheat, causing the flashlight to become hot, posing burn and fire hazards.
Remedy	Contact company for refund. Customers will be asked to provide a photo of the tag located under the ear in the hat.
How to Tell if Your Toy Might Have Been Recalled	This recall involves the Nickelodeon PAW PATROL Deluxe Marshall Hat sold with an accessory flashlight. The PAW PATROL Marshall hats are red with a yellow ribbon, black and white spotted dog ears and a black flashlight attached to the side of the hat. The flashlight is included with the hat and they share the SKU number. Only flashlights with SKU 01292093 and date codes 1703RY01, 1603RY01, and 1503RY01 are involved in this recall. The SKU number and date codes are on the sewn in label under the ear on the hat.
CPSC Recall Website	https://www.cpsc.gov/Recalls/2018/spirit-halloween-recalls-nickelodeon-paw-patrol-marshall-hat-with-flashlight-due-to
Recall Date	4/5/2018
Number of Units Recalled	20,000
Incidents/Injuries	The firm has received three reports of the flashlight overheating and one report of an overheating flashlight in Canada. No injuries or fires have been reported.



Name of Toy	INNOCHEER Musical Instruments Set
Manufacturer/Distributor	Creative Sto, of China
Original Dates of Sale	June 2018 – August 2018
Original Price before Recall	\$21 - \$33
Why Toy Is a Hazard	Paint on the maracas, xylophone and carrying case contains levels of lead that exceed the federal lead paint ban. Lead is toxic if ingested by young children and can cause adverse health issues.
Remedy	Consumers should immediately stop using the recalled instrument sets and carrying case, take them away from children and contact Creative Sto for a full refund, including the cost of shipping the product back to Creative Sto. The firm is contacting all known purchasers directly.
How to Tell if Your Toy Might Have Been Recalled	The 18-piece instrument sets have one xylophone, two mallets, two maracas, one jingle stick, one sleigh bell, four shaker eggs, two finger castanets, one rainbow bell stick, one mini tambourine and one triangle with striker. The instruments set comes inside a clear plastic bag that measures about 8.9 inches by 8.9 inches by 3.2 inches and has a green trim and a yellow zipper and handles. INNOCHEER is printed in green on the front of the bag.
CPSC Recall Website	https://www.cpsc.gov/Recalls/2019/Childrens-Toy-Instrument-Sets-Recalled-Due-to-Violation-of-the-Federal-Lead-Paint-Ban-Made-by-Creative-Sto-and-Sold-Exclusively-at-Amazon-com-Recall-Alert
Recall Date	10/26/2018
Number of Units Recalled	440
Incidents/Injuries	None Reported



Endnotes

1 Ally Marotti, “Toy-maker VTech to pay \$650,000 to settle FTC charges over children’s privacy violations,” *Chicago Tribune*, 8 January 2018. <http://www.chicagotribune.com/business/ct-biz-connected-toys-ftc-20180108-story.html>.

2 The Mozilla Foundation, Privacy Not Included: Amazon Fire HD Kids Edition, <https://foundation.mozilla.org/en/privacynotincluded/products/amazon-fire-hd-kids-edition/> (accessed on 6 November 2018).

3 U.S. PIRG Education Fund, Lead in Fidget Spinners, <https://uspirg.org/reports/usp/lead-fidget-spinners-0>, (accessed on 31 October 2018).

4 U.S. Consumer Product Safety Commission, Recall Listings, <https://www.cpsc.gov/Recalls> (accessed on 30 October 2018).

5 U.S. Consumer Product Safety Commission, Injury Statistics, See: Toy-Related Deaths and Injuries, <https://www.cpsc.gov/Research--Statistics/Injury-Statistics> (accessed on 30 October 2018).

6 U.S. Consumer Product Safety Commission, The Consumer Product Safety Improvement Act (CPSIA), <https://www.cpsc.gov/Regulations-Laws--Standards/Statutes/The-Consumer-Product-Safety-Improvement-Act>, (accessed on 30 October 2018).

7 Ibid.

8 National Public Radio, After Ikea Dresser Recall, Another Toddler Reportedly Died In Tip-Over, <https://www.npr.org/sections/thetwo-way/2017/10/19/558850616/after-ikea-dresser-recall-another-toddler-reportedly-died-in-tip-over>, (accessed 30 October 2018).

9 Centers for Disease Control and Prevention, Fourth National Report on Human Exposure to Environmental Chemicals, February 2009.

10 Centers for Disease Control and Prevention, Lead: Toys, <https://www.cdc.gov/nceh/lead/tips/toys.htm>, (accessed on 26 October 2018).

11 Centers for Disease Control and Prevention, Lead: Prevention Tips, <https://www.cdc.gov/nceh/lead/tips.htm>, (accessed on 26 October 2018).

12 See note 10.

13 Ibid.

14 Ibid.

15 Consumer Product Safety Commission, Total Lead Content, <https://www.cpsc.gov/Business--Manufacturing/Business-Education/Lead/Total-Lead-Content>, (accessed on 26 October 2018).

16 Ibid.

- 17 Consumer Product Safety Commission, Lead Total Content, <https://www.cpsc.gov/Business--Manufacturing/Business-Education/Lead/Total-Lead-Content>, (accessed on 30 October 2018)
- 18 CPSC Announces Final Ban on Lead Containing Paint, <https://www.cpsc.gov/Recalls/1977/cpsc-announces-final-ban-on-lead-containing-paint>, (accessed on 30 October 2018).
- 19 Ibid.
- 20 American Academy of Pediatrics, Testimony of Dana Best, MD, MPH, FAAP, on Behalf of the American Academy of Pediatrics: Energy and Commerce Subcommittee on Commerce, Trade, and Consumer Protection: Protecting Children from Lead Paint Imports, 20 September 2007.
- 21 Consumer Product Safety Commission, BSN Sports Recalls Rubber Critter Toys Due to Violation of Federal Lead Paint Ban, <https://www.cpsc.gov/Recalls/2018/bsn-sports-recalls-rubber-critter-toys-due-to-violation-of-federal-lead-paint-ban>, (accessed on 30 October 2018).
- 22 Ibid.
- 23 World Health Organization, Boron in Drinking-water, 2003. http://www.who.int/water_sanitation_health/water-quality/guidelines/boron.pdf?ua=1.
- 24 Environmental Protection Agency, Health Effects Support Document for Boron, 2008. https://www.epa.gov/sites/production/files/2014-09/documents/health_effects_support_document_for_boron.pdf.
- 25 Ibid.
- 26 National Institutes of Health: U.S. National Library of Medicine: Toxnet, Borax, <https://toxnet.nlm.nih.gov/cgi-bin/sis/search/a?dbs+hsdb:@term+@DOCNO+328>, (accessed on 30 October 2018).
- 27 Environmental Protection Agency, Summary Document from the Health Advisory for Boron and Compounds, 2008. https://www.epa.gov/sites/production/files/2014-09/documents/summary_document_from_the_ha_for_boron.pdf.
- 28 NIOSH, Borates, tetra, sodium salts (Anhydrous), <https://www.cdc.gov/niosh/npg/npgd0057.html>, (accessed on 30 October 2018).
- 29 Directive 2009/48/EC Of The European Parliament and of the Council, 2009. <https://eur-lex.europa.eu/legal-content/EN/TXT/?uri=CELEX:32009L0048>.
- 30 UL, Slime in the news, and it's not all child's play, according to governing bodies, <https://www.ul.com/inside-ul/slime-products-news/>, (accessed on 30 October 2018).
- 31 See note 28.
- 32 An example of borax-free slime can be found here: <https://www.amazon.com/Aitsite-Modeling-Non-Sticky-Scented-Children/dp/B077JNHT4G/>
- 33 See note 5.
- 34 Consumer Product Safety Commission, Office of Compliance, Small Parts Regulations: Toys and Products Intended for Use by Children Under 3 Years Old: 16 C.F.R Part 1501 and 1500.50-53, January 2001
- 35 16 CFR 1500.19(b)(1).
- 36 Marbles: 16 CFR 1500.19(a)(4) (i); vending machines and toy bins: 16 CFR 1500.19(a)(8).
- 37 16 CFR 1501.2(b).
- 38 16 CFR 1501.3.
- 39 16 CFR 1500.20; Amazon, CPSIA Choking Hazard Warnings and Material Content Limits, https://sellercentral.amazon.com/gp/help/external/200292910?language=en-US&ref=mpbc_200296270_cont_200292910, (accessed on 30 October 2018).

- 40 16 CFR 1500.19
- 41 Accessed on 16 October 2018; 16 CFR 1500.19(b)(1).
- 42 16 CFR 1500.20.
- 43 Toy Association, U.S. Sales Data, <https://www.toyassociation.org/ta/research/data/u-s-sales-data/toys/research-and-data/data/us-sales-data.aspx>, (accessed on 29 October 2018)
- 44 Edge Ascential, Toys on Amazon: 2017 Year in Review, <https://www.ascentialedge.com/blog/toys-amazon-2017-year-review>, (accessed on 29 October 2018).
- 45 Accessed on 16 October 2018.
- 46 16 CFR 1500.18(a)(17).
- 47 See note 5.
- 48 16 CFR 1500.18(a)(17).
- 49 16 CFR 1500.19(b)(3)(i).
- 50 Ibid.
- 51 Consumer Product Safety Commission, CPSC Safety Alert: CPSC Warns Consumers of Suffocation Danger Associated with Children's Balloons, 2012.
- 52 See note 5.
- 53 16 CFR 1500.19(b)(2).
- 54 See note 50.
- 55 See note 36.
- 56 Consumer Product Safety Commission, CPSC Approves Strong Federal Safety Standards for High-Powered Magnet Sets to Protect Children and Teenagers (press release), 25 September 2014.
- 57 Consumer Product Safety Commission, Buckyballs and Buckycubes Refunds Now Available Through BuckyballsRecall.com; Recall To Refund Will Last Until Jan. 2015, <https://www.cpsc.gov/Newsroom/News-Releases/2014/Buckyballs-and-Buckycubes-Refunds-Now-Available/>, (accessed on 30 October 2018).
- 58 Lena Sun, *Washington Post*, "Popular magnets pose risk if swallowed," https://www.washingtonpost.com/national/health-science/popular-magnets-pose-risk-if-swallowed/2012/01/25/gIQA3EwgVQ_story.html?utm_term=.3a5fb15ea8a4, 27 January 2018.
- 59 Consumer Product Safety Commission, CPSC Warns High-Powered Magnets and Children Make a Deadly Mix, <https://www.cpsc.gov/Newsroom/News-Releases/2012/CPSC-Warns-High-Powered-Magnets-and-Children-Make-a-Deadly-Mix>, (accessed on 30 October 2018).
- 60 Teri Sforza, "Watchdog: Magnets in Toys Can Be Deadly," *Orange County Register*, 1 October 2015; Consumer Federation of America, CPSC Issues Final Rule to Protect Children from Hazardous High Powered Magnets (press release), 24 September 2014; Elizabeth Cohen, "Powerful Magnets in Toys Raise Risks from Swallowing," *CNN*, 5 June 2012; Consumer Product Safety Commission, CPSC Approves Strong Federal Safety Standards for High Powered Magnet Sets to Protect Children and Teenagers (press release), 25 September 2014.
- 61 See note 55.
- 62 Jayne O'Donnell, "CPSC May Ban Tiny Magnets that Killed a Child," *USA Today*, 4 September 2014.
- 63 Consumer Federation of America, Pediatricians and Consumer Advocates Ask CPSC for Swift Action on High-Powered Magnet Safety Standards (press release), 1 October 2015.

64 Consumer Product Safety Commission, CPSC Approves Strong Federal Safety Standard for High-Powered Magnet Sets to Protect Children and Teenagers, <https://www.cpsc.gov/Newsroom/News-Releases/2014/CPSC-Approves-Strong-Federal-Safety-Standard-for-High-Powered-Magnet-Sets-to-Protect-Children-and-Teenagers>, (accessed on 26 October 2018).

65 Matt Strickland, Daniel Rosenfield and Annie Fecteau, “Magnetic Foreign Body Injuries: A Large Pediatric Hospital Experience,” *The Journal of Pediatrics* 165 (2): 332-335, May 2014.

66 United States Court of Appeals for the Tenth Circuit, *Zen Magnets, LLC v Consumer Product Safety Commission*, <https://www.ca10.uscourts.gov/opinions/14/14-9610.pdf>, (accessed on 6 November 2018).

67 Federal Register, Final Rule: Safety Standard for Magnet Sets: A Rule by the Consumer Product Safety Commission, 3 October 2014.

68 ASTM International, F963-11, Standard Consumer Safety Specification for Toy Safety (West Conshohocken, PA: ASTM International, 2012).

69 See note 64.

70 Peder Magee, Federal Trade Commission, *Happy 20th Birthday, COPPA* (blog post), 22 October 2018, available at <https://www.ftc.gov/news-events/blogs/business-blog/2018/10/happy-20th-birthday-coppa>.

71 Stacey Gray, Future of Privacy Forum, “Federal Trade Commission: COPPA Applies to Connected Toys,” Blog Post 26 June 2017, available at <https://fpf.org/2017/06/26/federal-trade-commission-coppa-applies-connected-toys/>.

72 FBI Public Service Announcement I-071717(Revised), “CONSUMER NOTICE: INTERNET-CONNECTED TOYS COULD PRESENT PRIVACY AND CONTACT CONCERNS FOR CHILDREN,” 17 July 2017, available at <https://www.ic3.gov/media/2017/170717.aspx>.

73 Ally Marotti, “Toy-maker VTech to pay \$650,000 to settle FTC charges over children’s privacy violations,” *Chicago Tribune*, 8 January 2018. <http://www.chicagotribune.com/business/ct-biz-connected-toys-ftc-20180108-story.html>.

74 Ibid.

75 Ibid.

76 Ibid.

77 The Mozilla Foundation, Privacy Not Included, <https://foundation.mozilla.org/en/privacynotincluded>, (accessed on 6 November 2018).

78 The Mozilla Foundation, Privacy Not Included: Amazon Fire HD Kids Edition, <https://foundation.mozilla.org/en/privacynotincluded/products/amazon-fire-hd-kids-edition/>, (accessed on 6 November 2018).

79 Ibid.

80 Ibid.

81 The guide, published in June 2013, is available at <https://www.democraticmedia.org/content/protecting-childrens-online-privacy-parents-guide-new-stronger-kids-privacy-rules-digital>

82 National Institute on Deafness and Other Communication Disorders, National Institutes of Health, U.S. Department of Health and Human Services, *NIDCD Fact Sheet: Noise Induced Hearing Loss*, February 2017 (last updated).

83 A.S. Niskar, et al., “Prevalence of Hearing Loss among Children 6 to 19 Years of Age: The Third National Health and Nutrition Examination Survey,” *Journal of the American Medical Association* 279: 1071-1075, 1998.

84 American Speech-Language-Hearing Association, *The Prevalence and Incidence of Hearing Loss in Children*, <https://www.asha.org/uploadedFiles/aud/InfoSeriesPrevalenceIncidenceofHearingLossChildren.pdf>, (accessed on 30 October 2018).

85 Federal Register, Safety Standard Mandating ASTM F963 for Toys, <https://www.federalregister.gov/documents/2017/12/04/2017-26009/safety-standard-mandating-astm-f963-for-toys>, (accessed on 30 October 2018)

86 ASTM International, F963-11, Standard Consumer Safety Specification for Toy Safety (West Conshohocken, PA: ASTM International, 2012).

87 Kids in Danger, Playing with Fire Hazards: An analysis of children's products recalled for fire hazards, 2017. <https://kidsindanger.org/wp-content/uploads/Playing-with-Fire-Hazards-Sept-2017.pdf>.

88 U.S. Consumer Product Safety Commission, Michaels Recalls Pottery Wheel Kits Due to Fire and Burn Hazard, <https://www.cpsc.gov/Recalls/2018/michaels-recalls-pottery-wheel-kits-due-to-fire-and-burn-hazard>, 17 May 2018. U.S. Consumer Product Safety Commission, Michaels Recalls Spin Art Kits Due to Fire and Burn Hazards, <https://www.cpsc.gov/Recalls/2018/Michaels-Recalls-Spin-Art-Kits-Due-to-Fire-and-Burn-Hazards>, 17 May 2018. U.S. Consumer Product Safety Commission, Fisher-Price Recalls Infant Motion Seats Due to Fire Hazard, <https://www.cpsc.gov/Recalls/2018/FisherPrice-Recalls-Infant-Motion-Seats-Due-to-Fire-Hazard>, 24 October 2017. U.S. Consumer Product Safety Commission, Spirit Halloween Recalls Nickelodeon PAW PATROL Marshall Hat with Flashlight Due to Fire and Burn Hazards, <https://www.cpsc.gov/Recalls/2018/spirit-halloween-recalls-nickelodeon-paw-patrol-marshall-hat-with-flashlight-due-to>, 5 April 2018.

89 U.S. Consumer Product Safety Commission, Michaels Recalls Pottery Wheel Kits Due to Fire and Burn Hazard, <https://www.cpsc.gov/Recalls/2018/michaels-recalls-pottery-wheel-kits-due-to-fire-and-burn-hazard>, (accessed on 30 October 2018), and U.S. Consumer Product Safety Commission, Michaels Recalls Spin Art Kits Due to Fire and Burn Hazards, <https://www.cpsc.gov/Recalls/2018/Michaels-Recalls-Spin-Art-Kits-Due-to-Fire-and-Burn-Hazards>, (accessed on 30 October 2018).

90 U.S. Consumer Product Safety Commission, Fisher-Price Recalls Infant Motion Seats Due to Fire Hazard, <https://www.cpsc.gov/Recalls/2018/FisherPrice-Recalls-Infant-Motion-Seats-Due-to-Fire-Hazard> (accessed on 30 October 2018).

91 U.S. Consumer Product Safety Commission, CPSC Regulates Children's Toys To Reduce Small Parts Injuries, <https://www.cpsc.gov/content/cpsc-regulates-childrens-toys-to-reduce-small-parts-injuries>, (accessed on 30 October 2018).

92 See note 3.

93 See note 4. We searched for recalls from October 5, 2017 through October 26, 2018.

94 See note 5.

95 U.S. Consumer Product Safety Commission, CPSC Premium Toys Seminar, <https://www.cpsc.gov/PageFiles/120253/celstalk.pdf>, (accessed on 30 October 2018)